

IEC Load Switches, 16...100 A

Product Selection/Catalog Number Explanation

Bulletin 194E Enclosed Disconnect Load Switches with 194R Handles (with Defeater, suitable for 3 padlocks)

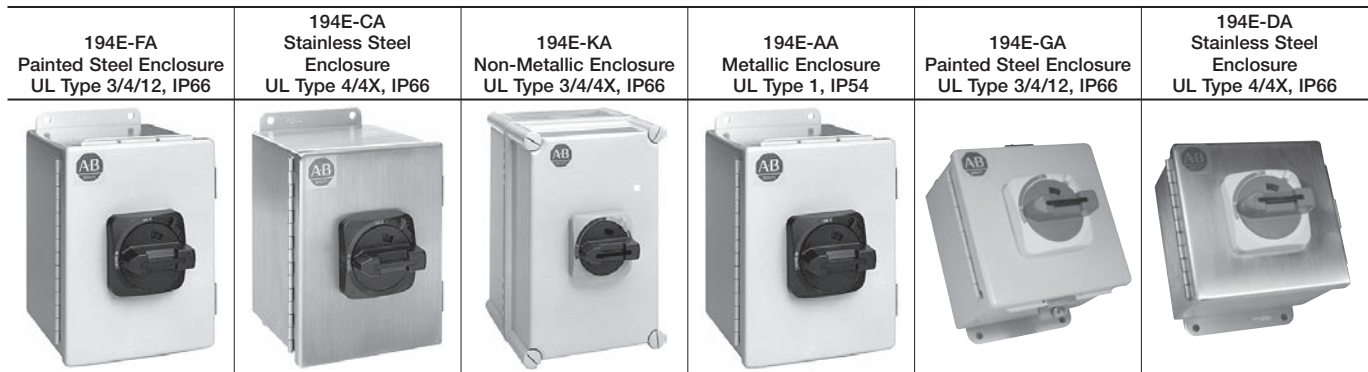

2

Cat. No. Explanation *§

194E - FA 32 E - P11 - P11 - 6
a b c d d e

<i>a</i>	
Code	Enclosure Type
FA	UL Type 3/4/12, IP66 Painted Steel, Hinged, for 16...100 A switches
GA	UL Type 3/4/12, IP66 Painted Steel, Hinged, in 6 x 6 x 4 in. size, for 16...32 A 3-pole switches ‡
CA	UL Type 4/4X, IP66 Stainless Steel, Hinged, for 16...100 A switches
DA	UL Type 4/4X, IP66 Stainless Steel, Hinged, in 6 x 6 x 4 in. size, for 16...32 A 3-pole switches ‡
KA	UL Type 3/4/4X, IP66 Non-Metallic, for 16...100 A switches
AA	UL Type 1, IP54 Painted Steel, Hinged, for 16...100 A switches (Same enclosure as FA without gasketing)

<i>b</i>	
Code	Load Size
16	16 A
20	25 A
32	32 A
40	40 A
63	63 A
80	80 A
00	100 A

<i>c</i>	
Code	Handle Color (194R-HS _ _)
Blank	Grey/Black
E	Red/Yellow

<i>d</i>	
Code	Left Side + Right Side Modifications*
Blank	No Option
-P11	1 N.O. + 1 N.C. Auxiliary Contacts
-PL11	1 N.O. + 1 N.C.L.B. Auxiliary Contacts
-P22	2 N.O. + 2 N.C. Auxiliary Contacts
-PD10	1 N.O. E.B.
-NP	Additional Pole
-PE	Grounding Pole
-TN	Neutral Pole

<i>e</i>	
Code	Switch Type
Blank	3-pole switch
-6	6 Pole switch§

* Modifications: Up to two suffix codes may be added to an enclosed disconnect load switch. See Guidelines, page 2-409. If only one accessory is chosen, it is mounted on the left side of the switch.

§ To order the cat. no. 194E-FA40/FA63 or 194E-CA40/CA63 in the larger 80/100A sized enclosure, add an "X" after the handle color. For example, Cat. No. **194E-FA40E** becomes Cat. No. **194E-FA40EX**.

‡ GA and DA type enclosures: use with 3-pole 16...32 A switches only.

§ Special order; allow for longer delivery time.

Frequently Ordered Bulletin 194E Enclosed Switches with Bulletin 194R Handle

Description	Rated Current (A)	Dimension Reference	Handle Color	Cat. No.*
Stainless steel enclosure, IP66/Type 4/4X	25	A1	Black	194E-CA20
			Red/Yellow	194E-CA20E
	32	A1	Black	194E-CA32
			Red/Yellow	194E-CA32E
	63	A1	Black	194E-CA63
			Red/Yellow	194E-CA63E
Painted steel enclosure, IP66/Type 3/4/12	25	A1	Black	194E-FA20
			Red/Yellow	194E-FA20E
	32	A1	Black	194E-FA32
			Red/Yellow	194E-FA32E
	40	A1	Black	194E-FA40
			Red/Yellow	194E-FA40E
Non-metallic enclosure, IP66/Type 4/4X	25	C1	Black	194E-KA20
			Red/Yellow	194E-KA20E

* Modifications: Up to two suffix codes may be added to an enclosed disconnect load switch. See Guidelines, page 2-409. If only one accessory is chosen, it is mounted on the left side of the switch.

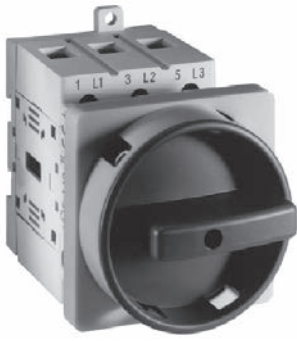

Bulletin 194E IEC Load Switches

- Suitable as At-Motor Disconnect Switch (UL508)
- 16, 25, 32, 40, 63, 80, 100 A Inductive Load-Rated Switches
- IP66/ UL Type 1/3/3R/12 Operating Handles
- IP2LX Finger-Safe Terminals
- 3- and 6-Pole Versions; Add-on Accessory Poles to Make 4-, 5-, 7- and 8-Pole Units
- Front/Door or DIN/Base Mounting Configurations
- Available in OFF-ON and Changeover Configurations
- 3- and 6-Pole Enclosed Switches
- Optional Thermoplastic Enclosures
- Positive-Guided Actuation
- Padlockable Handles Available (up to 3 padlocks)

Table of Contents

Product Selection 2-405
 Accessories..... 2-409
 Specifications..... 2-415
 Approximate
 Dimensions..... 2-417

Standards Compliance

IEC 60947-1
 IEC 60947-3 Low-voltage
 switchgear and control gear
 part 3
 UL 508
 CSA: C22.2 No. 14

Certifications

UL Listed (File No. E14841, Guide NLRV)
 CSA Certified (LR 13908)
 IEC, VDE and BS
 CE
 RINA — Italian Naval Registry
 CCC

Description

Bulletin 194E load switches are designed for use as local motor isolation and disconnect switch applications. Available with 3- and 6-pole versions with add-on additional poles, grounding and neutral terminals and auxiliary contacts, Bulletin 194Es share the same operating handles as the Bulletin 194L Control and Load Switches.

Bulletin 194E switches are offered in two mounting styles, Front/Door and Base/DIN configurations for a variety of installations. Switch body styles for Bulletin 194E base-mounted switches include standard interlock shaft; Bulletin 194E front-mounted switches include standard shaft. Two-position OFF-ON switch is used to connect or disconnect a variety of inductive loads, including solenoids, valves, magnetic starters, relays, and motors. Handles featuring marked legend plates are available in Selector-Knob, Disk-Style, Rectangular-Style and Key-Operated versions. Selector-Knob versions are available in three sizes. Most handles are available in colors of Grey/Black or Red/Yellow and have padlockable versions.

Cat. No. Explanation

194E 16...100 A Small-Frame Switches (Handles listed on page 2-400)



3-Pole Base Mount



3-Pole Front Mount



6-Pole Base Mount



6-Pole Front Mount

194E – A 32 – 1753

a
b
c

a

Installation Type	
Code	Description
A	Base/DIN Mounting
E	Front/Door Mounting

b

Load Size	
Code	Description
16	16 A
25	25 A
32	32 A
40	40 A
63	63 A
80	80 A
100	100 A

c

Function/Circuit Diagram Ref. #			
Code	Function	Description	Circuit Diagram Ref. #
1753	OFF/ON	3-Pole, 2-Position (90°)	1753
1756	OFF/ON	6-Pole, 2-Position (90°)	1756
1783	OFF/ON	3-Pole, 2-Position (90° - inverted)	1783
3753	Changeover	3-Pole, 3-Position (90°)	3753

Frequently Ordered* OFF-ON 3-Pole Switch (includes operating shaft) (Handles listed on page 2-406)

Function Switching Angle	No. of Circuits	Contact Target Configuration X = Contact Closed O = Contact Open		Handle Position	Rated Current [A]	AC23A Rated Power [kW] at 690V AC 50 Hz	Hp @ 480V AC 60 Hz 3 Ø	OFF-ON 3-Pole Switch (includes operating shaft)		
		OFF/0	ON/1					Base-Mounted	Front-Mounted	
								Cat. No.	Cat. No.	
	1	O	X		16	7.5	7.5	194E-A16-1753	194E-E16-1753	
	2	O	X		25	11	10	194E-A25-1753	194E-E25-1753	
	3	O	X		32	15	15	194E-A32-1753	194E-E32-1753	
						40	18.5	20	194E-A40-1753	194E-E40-1753
						63	22	25	194E-A63-1753	194E-E63-1753
						80	37	40	194E-A80-1753	194E-E80-1753
						100	45	50	194E-A100-1753	194E-E100-1753







Frequently Ordered* OFF-ON 6-Pole Switch (includes operating shaft) (Handles listed on page 2-406)

Function Switching Angle	No. of Circuits	Contact Target Configuration X = Contact Closed O = Contact Open		Handle Position	Rated Current [A]	AC23A Rated Power [kW] at 690V AC 50 Hz	Hp @ 480V AC 60 Hz 3 Ø	OFF-ON 6-Pole Switch (includes operating shaft)	
		OFF/0	ON/1					Base-Mounted	Front-Mounted
								Cat. No.	Cat. No.
	1	O	X		16	7.5	7.5	194E-A16-1756	194E-E16-1756
	2	O	X		25	11	10	194E-A25-1756	194E-E25-1756
	3	O	X		32	15	15	194E-A32-1756	194E-E32-1756
	4	O	X		40	18.5	20	194E-A40-1756	194E-E40-1756
	5	O	X		63	22	25	194E-A63-1756	194E-E63-1756
	6	O	X		80	37	40	194E-A80-1756	194E-E80-1756
						100	45	50	194E-A100-1756

* See Catalog No. Explanation for more load size and change-over switch options.

Bulletin 194E
IEC Load Switches, 16...100 A
 Product Selection/Catalog Number Explanation







Bulletin 194E/194L Handles (for use with Bulletin 194E Switches)

Color	Handles (Includes Legend Plate and Control Knob)			
Red/Yellow (Emergency Stop colors)	 Type I (IP66, UL Type 3/3R/12)	 Type L (IP66, UL Type 3/3R/12) With Locking For One Padlock (Padlock Not Included)	 Type N (IP66, UL Type 3/3R/12)§	Bulletin 194L handles are available in both screw fixing and 22.5 mm mounting hole style.
Black/Grey (Standard Operation colors)	 Type A (IP66, UL Type 3/3R/12)	 Type E (IP66, UL Type 3/3R/12) With Locking For One Padlock (Padlock Not Included)	 Type G (IP66, UL Type 3/3R/12)§	

§ These handles are for use with -175 and -178 (ON-OFF) switches only and are dual marked with ON-OFF and 1-0.

Cat. No. Explanation

194L - HE 6 N - 175

a		b			c			d		
Code	Installation Type	Code	Legend Plate Type	Color	Code	Description	Legend Marking			
HC	22.5 mm Mounting Hole Style Handle* (for use with front-mounted switches)	A	Square	Grey/Black	175	O-I				
HE	Screw-Mounting Handle (for use with front- and base-mounted switches)	I	Square	Red/Yellow	175I	OFF-ON				
4	A, E, I, L*	48 mm x 48 mm (1-57/64 in. x 1-57/64 in.)	E	Square/Lockable	Grey/Black	350	1-0-2 (Reversing)			
	S	48 mm x 62 mm (1-57/64 in. x 2-7/16 in.)	L	Square/Lockable	Red/Yellow					
6	A, E, I, L	64 mm x 64 mm (2-33/64 in. x 2-33/64 in.)	G	Disc/Lockable (up to 3 locks)	Grey/Black	375	1-0-2 (90 degrees) (Changeover)			
	G, N*‡	67 mm x 67 mm (2-41/64 in. x 2-41/64 in.)	N	Disc/Lockable (up to 3 locks)	Red/Yellow					
	S	64 mm x 78 mm (2-33/64 in. x 3-5/64 in.)	S	Large Square with extra legend area	Grey/Black					
8	A, I	88 mm x 88 mm (3-15/32 in. x 3-15/32 in.)	* For 22.5 mm mounting hole style handle (code HC), select either handle type A, E, I, or L with 48 x 48 mm legend plate size (code 4) only or handle type G or N with 64 x 64 mm legend plate size (code 6) only.		178	O-I				
	G, N§	90 mm x 90 mm (3-35/64 in. x 3-35/64 in.)	* Order 194E- 16 A Type G and N handles as Cat. No. 194E-HE4N-175 or 194E-HE4G-175					178I	OFF-ON	
		‡ Use Type G and N with ON-OFF function only (selection "d", code -175)								
		§ Cat. No. 194R-HE front-mounting switch only								

Frequently Ordered 194L Handles — OFF-ON Base/Front-Mounted 3- and 6-Pole Switch Handles (Switch Body listed on page 2-405)

Handle Type	Degree of Protection	Handle Color	Bezel Plate Size	For Use With	Legend Plate Marking	Cat. No.
E	IP66 (UL Type 1) (UL Type 3/3R/12)	Black/Grey	48 x 48 mm (1-57/64 x 1-57/64 in.)	194E-16...63 A 194L-E12...40 A, -1753 194L-A12...40 A, -1753	0-1 OFF-ON	194L-HE4E-175 194L-HE4E-175I
L		Red/Yellow	48 x 48 mm (1-57/64 x 1-57/64 in.)	194E-16...63 A 194L-E12...40 A, -1753 194L-A12...40 A, -1753	0-1 OFF-ON	194L-HE4L-175 194L-HE4L-175I
G	IP66 (UL Type 3/3R/12)	Black/Grey	54 x 54 mm (2-1/8 x 2-1/8 in.)	194E-16 A	0-1 OFF-ON	194E-HE4G-175
			67 x 67 mm (2-41/64 x 2-41/64 in.)	194E-25...100 A 194L-E12...40 A, -1753 194L-A12...40 A, -1753	0-1 OFF-ON	194L-HE6G-175
			88 x 88 mm (3-15/32 x 3-15/32 in.)	194E-40...100 A	0-1 OFF-ON	194L-HE8G-175
N		Red/Yellow	54 x 54 mm (2-1/8 x 2-1/8 in.)	194E-16 A	0-1 OFF-ON	194E-HE4N-175
			67 x 67 mm (2-41/64 x 2-41/64 in.)	194E-25...100 A 194L-E12...40 A, -1753 194L-A12...40 A, -1753	0-1 OFF-ON	194L-HE6N-175
			88 x 88 mm (3-15/32 x 3-15/32 in.)	194E-40...100 A	0-1 OFF-ON	194L-HE8N-175
L	IP66 (UL Type 3/3R/12)	Red/Yellow	48 x 48 mm (1-57/64 x 1-57/64 in.)	194L-E12...40 A, -1753	0-1 OFF-ON	194L-HC4L-175 194L-HC4L-175I

Bulletin 194E Open and Enclosed Switch Kits

Cat. No. Explanation

194E - Y 32 - 1753 - 6N

a b c d

<i>a</i>		<i>b</i>		<i>c</i>		<i>d</i>	
Code	Installation Type	Code	Load Size	Code	Configuration	Code	Handle Style
A	Base/DIN Mounting, open type switch	16	16 A*	1753	3-Pole OFF/ON (90°)	4N	194E-HE4N-175 (use with 16 A Switch)
E	Front/Door Mounting, open type switch	25	25 A	1756	6-Pole OFF/ON (90°)	4G	194E-HE4G-175 (use with 16 A Switch)
Y	Enclosed Base Mounting Switch With Handle (Uses IP66 ABS thermoplastic enclosure)	32	32 A			4A	194L-HE4A-175 (use with 16...100 A Switch)
		40	40 A			6N	194L-HE6N-175 (use with 25...100 A Switch)
		63	63 A			6G	194L-HE6G-175 (use with 25...100 A Switch)
		80	80 A			6A	194L-HE6A-175 (use with 25...100 A Switch)
		100	100 A				

* For 16 A Enclosed Switch: use "16M" (3-pole enclosure has M16/20 knockouts, 6-pole 16 A enclosure has M25/32 knockouts). For 25/32 A Enclosed Switch with M20/25 metric knockouts: use "25M" or "32M".

Frequently Ordered Switch Kits — OFF-ON Front- and Base-Mounted 3-Pole Switch With Cat. No. 194L-HE6N-175 Red/Yellow Handle

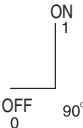
	Function Switching Angle	Rated Current [A]	AC23A Rated Power [kW] at 690V AC	HP @ 480V AC 60 Hz, 3 Ø	Base-Mounted Cat. No.	Front-Mounted Cat. No.
		25	7.5	10	194E-A25-1753-6N	194E-E25-1753-6N
		32	11	15	194E-A32-1753-6N	194E-E32-1753-6N
		63	18.5	25	194E-A63-1753-6N	194E-E63-1753-6N

Base-Mounting Distribution Switches (handles are pre-assembled to switch)

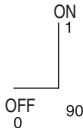
	Function Switching Angle	No. of Circuits	Contact Target		Handle Color	Legend Plate Marking	Lockable (One Padlock)	Rated Current [A]	AC23A Rated Power [kW] at 690V AC	Hp @ 480V AC 60 Hz, 3 Ø	Cat. No.
			OFF/0	ON/1							
		1 2 3	O O O	X X X	Red/Yellow	0-1	Yes	25	11	—	194E-A25-1753-R
					Black/Grey	0-1	No				194E-A25-1753-Q
					Red/Yellow	0-1	Yes	32	15	—	194E-A32-1753-R
					Black/Grey	0-1	No				194E-A32-1753-Q

Frequently Ordered Enclosures — 3- and 6-Pole Enclosed Switches With Cat. No. 194L-HE6N-175 Red/Yellow Operating Handles

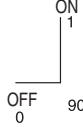
	No. of Poles	Function Switching Angle	Rated Current [A]	Handle Color	Cat. No.
 <p>Uses Base-Mounted Switches</p>	3		16	Red/Yellow	194E-Y16-1753-4N
			25		194E-Y25-1753-6N
			32		194E-Y32-1753-6N
			40		194E-Y40-1753-6N
	6		25	Red/Yellow	194E-Y25-1756-6N



IEC Load Switch Accessories

194E-E16...100 A, Front/Door Mounting

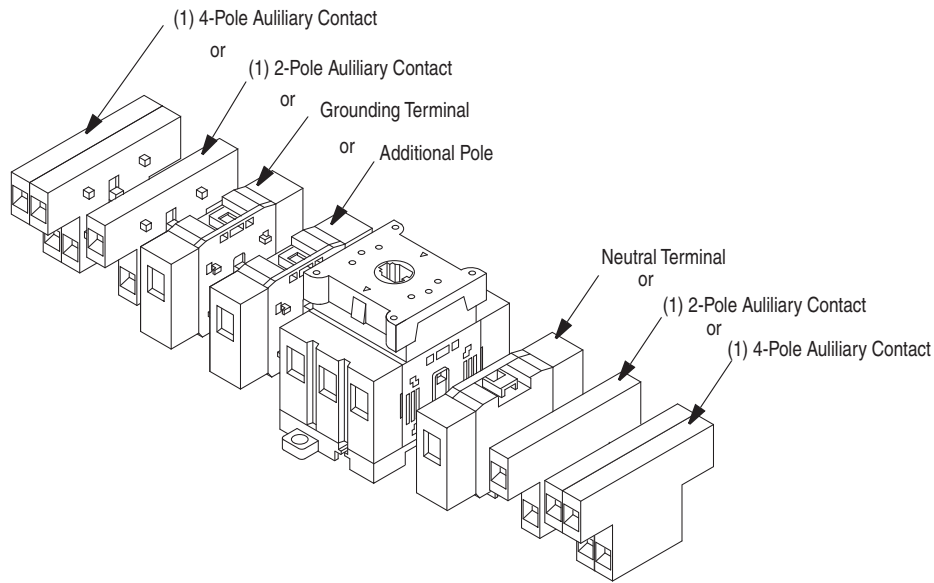

194E-A16...100 A, Base/DIN Rail Mounting

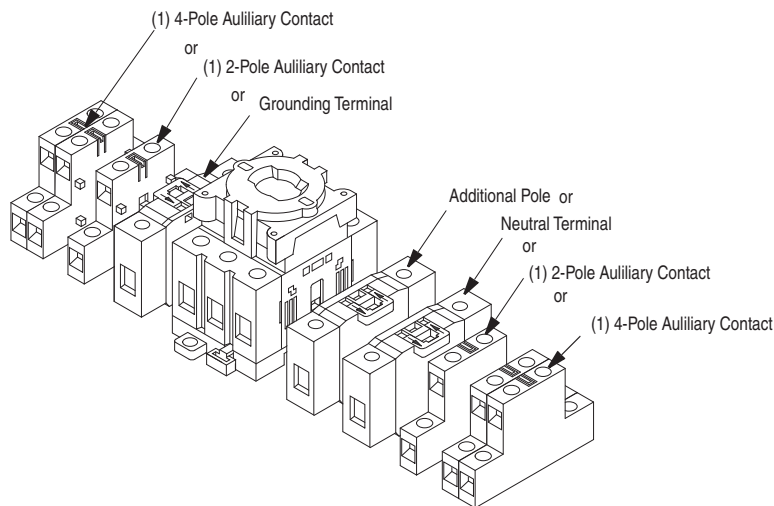

Accessory Configuration Guidelines

Accessory drawings represent modular, snap-on features of Bulletin 194E accessories. They are not suggesting possible accessory configurations. Use the following guidelines for choosing 194E accessory configurations.

- Up to two accessories may be added to the Bulletin 194E switch body.
- For the 194E 16, 25, 32, 40, or 63 A switches, the early break auxiliary contact (-PD10) may only be used in the following configurations:
 - As a single unit on either side of the switch
 - As a single unit on a side when used with a switch + 4th pole (-NP)
 - As a single unit on a side when used with a switch + ground terminal (-PE)
 - As a single unit on a side when used with a switch + neutral terminal (-TN)
 - No other auxiliary contact may be used in combinations with an early break auxiliary contact (-PD10)
- Other combinations of auxiliary contacts are permissible.
- For the 194E 80 and 100 A switches, any combination of auxiliary contacts, 4th pole, ground terminal, neutral terminal, and -PD10 is permissible.

Bulletin 194E
IEC Load Switches, 16...100 A
 Accessories

2

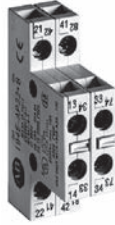
Auxiliary Contacts	No. of Auxiliary Contacts	For Use With	Cat. No.*
	1 N.O. + 1 N.C.	194E-A16...100	194E-A-P11
		194E-E16...100	194E-E-P11
	1 N.O. + 1 N.C.L.B.	194E-A16...100	194E-A-PL11
		194E-E16...100	194E-E-PL11
	2 N.O. + 2 N.C.	194E-A16...100	194E-A-P22
		194E-E16...100	194E-E-P22
	1 N.O.E.B.	194E-A16	194E-A16-PD10
		194E-A25...100	194E-A-PD10
		194E-E16	194E-E16-PD10
		194E-E25...100	194E-E-PD10

Additional Pole, 1 N.O.	For Use With	Cat. No.*
	194E-A16	194E-A16-NP
	194E-A25	194E-A25-NP
	194E-A32	194E-A32-NP
	194E-A40	194E-A40-NP
	194E-A63	194E-A63-NP
	194E-A80	194E-A80-NP
	194E-A100	194E-A100-NP
	194E-E16	194E-E16-NP
	194E-E25	194E-E25-NP
	194E-E32	194E-E32-NP
	194E-E40	194E-E40-NP
	194E-E63	194E-E63-NP
	194E-E80	194E-E80-NP
	194E-E100	194E-E100-NP

Earthing/Grounding Terminal	For Use With	Cat. No.*
	194E-A16	194E-A16-PE
	194E-A25/32	194E-A32-PE
	194E-A40/63	194E-A63-PE
	194E-A80/100	194E-A100-PE
	194E-E16	194E-E16-PE
	194E-E25/32	194E-E32-PE
	194E-E40/63	194E-E63-PE
	194E-E80/100	194E-E100-PE

6-Pole Mechanical Coupling*	For Use With	Cat. No.
	194E-16	194E-G3821
	194E-25/32	194E-G3660
	194E-40/63	194E-G3661
	194E-80/100	194E-G3662



Neutral Terminal	For Use With	Cat. No.*
	194E-A16	194E-A16-TN
	194E-A25/32	194E-A32-TN
	194E-A40/63	194E-A63-TN
	194E-A80/100	194E-A100-TN
	194E-E16	194E-E16-TN
	194E-E25/32	194E-E32-TN
	194E-E40/63	194E-E63-TN
	194E-E80/100	194E-E100-TN

* A maximum of two side-mount accessories may be added to a 194E switch (one on each side).

ABS Thermoplastic Enclosure — IP66, For High-Impact Applications (grounding screw included)	Description	No. of Poles	For Use With	Cat. No.
	For PG cable glands	3...4	194E-A25/32	194L-G3572
		3...4	194E-A40/63	194E-G3663
		6	194E-A25/32	
		6	194E-A40/63	194E-G3665
	For metric cable glands	3...4	194E-A80/100	194L-G3572M
		3...4	194E-A25/32	194E-G3663M
		3...4	194E-A40/63	
		6	194E-A25/32	194E-G3665M
		6	194E-A40/63	
		3...4	194E-A80/100	

Noryl Thermoplastic Enclosures — IP66, For Corrosion-Prone Applications (grounding screw included)	Description	No. of Poles	For Use With	Cat. No.
	For PG cable glands	3...4	194E-A25/32	194L-G3576
		6	194E-A25/32	194E-G3664
		3...4	194E-A40/63	
		6	194E-A40/63	194E-G3666
		3...4	194E-A80/100	
		For metric cable glands	3...4	194E-A25/32
	6		194E-A25/32	194E-G3664M
	3...4		194E-A40/63	
	6		194E-A40/63	194E-G3666M
	3...4	194E-A80/100		



Description	For Use With	Pkg. Qty.	Cat. No.
Additional Earth/Ground and Neutral Terminals — For Thermoplastic Enclosure	194L-G3663, G3664, G3665, G3666	5	194E-G3673
	194L-G3572 and G3676	5	194E-G3653

Terminal Covers	No. of Poles	For Use With	Cat. No.
	1	194E-16	194E-16-C1
	3	194E-16	194E-16-C3
		194E-25/32	194E-25-C3
		194E-40/63	194E-40-C3
	4	194E-80/100	194E-80-C3
		194E-25/32	194E-25-C4
	4	194E-40/63	194E-40-C4
		194E-80/100	194E-80-C4

* User must order (2) Bulletin 194E 3-Pole Switches separately.

* Coupling for changeover switch not available. Changeover switch must be ordered as a factory-assembled device (e.g., 194E-A25-3753).

Operating Shafts

	Length	Construction	Pkg. Qty.	Cat. No.
 <i>Standard Shaft (for front-mount switches)</i>	34 mm (1-11/32 in.)	Plastic	5	194L-G3380
		Metal	5	194E-G3688
 <i>Interlock Shaft (for base-mount switches)</i>	44 mm (1-47/64 in.) (Standard Length)	Plastic	5	194L-G2830
		Metal		194E-G3687
	52 mm (2-3/64 in.)	Plastic		194L-G3194
		Metal		194E-G3707
57 mm (2-15/64 in.)	Plastic	194L-G3195		

Bulletin 194E Load Switch Cat. No. Shaft Selection for use with 194E and 194L Thermoplastic Enclosures

Rated Current [A]	3-Pole Switches (-1753 suffix)		6-Pole Switches (-1756 suffix)		Changeover Switches (-3753 suffix)	
	194E-E...	194E-A...	194E-E...	194E-A...	194E-E...	194E-A...
16	plastic shaft (Cat. No. 194L-G3380)	plastic shaft (Cat. No. 194L-G2830)	metallic shaft (Cat. No. 194E-G3688)	metallic shaft (Cat. No. 194E-G3687)	metallic shaft (Cat. No. 194E-G3688)	metallic shaft (Cat. No. 194E-G3687)
25	plastic shaft (Cat. No. 194L-G3380)	plastic shaft (Cat. No. 194L-G2830)	metallic shaft (Cat. No. 194E-G3688)	metallic shaft (Cat. No. 194E-G3687)	metallic shaft (Cat. No. 194E-G3688)	metallic shaft (Cat. No. 194E-G3687)
32	plastic shaft (Cat. No. 194L-G3380)	plastic shaft (Cat. No. 194L-G2830)	metallic shaft (Cat. No. 194E-G3688)	metallic shaft (Cat. No. 194E-G3687)	metallic shaft (Cat. No. 194E-G3688)	metallic shaft (Cat. No. 194E-G3687)
40	metallic shaft (Cat. No. 194E-G3688)	metallic shaft (Cat. No. 194E-G3687)	metallic shaft (Cat. No. 194E-G3688)	metallic shaft (Cat. No. 194E-G3687)	metallic shaft (Cat. No. 194E-G3688)	metallic shaft (Cat. No. 194E-G3687)
63	metallic shaft (Cat. No. 194E-G3688)	metallic shaft (Cat. No. 194E-G3687)	metallic shaft (Cat. No. 194L-G3688)	metallic shaft (Cat. No. 194E-G3687)	metallic shaft (Cat. No. 194E-G3688)	metallic shaft (Cat. No. 194E-G3687)
80	metallic shaft (Cat. No. 194E-G3688)	metallic shaft (Cat. No. 194E-G3687)	metallic shaft (Cat. No. 194E-G3688)	metallic shaft (Cat. No. 194E-G3687)	metallic shaft (Cat. No. 194E-G3688)	metallic shaft (Cat. No. 194E-G3687)
100	metallic shaft (Cat. No. 194E-G3688)	metallic shaft (Cat. No. 194E-G3687)	metallic shaft (Cat. No. 194E-G3688)	metallic shaft (Cat. No. 194E-G3687)	metallic shaft (Cat. No. 194E-G3688)	metallic shaft (Cat. No. 194E-G3687)

Bulletin 194E
IEC Load Switches, 16...100 A
 Accessories/Other Accessories

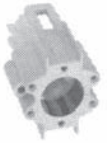

Shaft Extension Kits

 Shaft Extension	Length	For Use With	Pkg. Qty.	Cat. No.
	24 mm (15/16 in.) Per Extension	194E-A...	10	194L-G2853

Metal Shaft Extensions — With Padlock Provision in OFF Position





	Length	For Use With	Pkg. Qty.	Cat. No.
	110...235 mm (4-21/64...9-1/4 in.)	194E-A...	1	194L-G3393
230...350 mm (9-3/64...13-51/64 in.)	194L-G3394			

Metal Shaft Adaptor Kits — For use with 194R Type 4/4X Handles

	Metal shaft adaptor kits — for use with 194R Type 4/4X handles kit includes bezel adapter and 194R-R1 operating shaft. Operating handle (Cat. No. 194R-HS4) must be ordered separately.	For Use With	Pkg. Qty.	Cat. No.
		194E-A...	1	194E-G3675
	Metal Shaft Extension For modification of Cat. No. 194L-G3393/ G3394 when used with any switches other than 2-position, 90° rotation.	194E-A...	10	194L-G3399



Other Accessories

194L/194E 22.5 mm Mounting Hole Style Handles (Type B, D) (For Front-Mounted Switches)

 Type B	Description		Cat. No.
	22.5 mm Mounting Hole Style Handles (IP65) Handle Style: Knob Lever with Latch (For Use With 194E-E25...100 A, -1753) or 194L-E12...40 A		194L-HCB-001
 Type D	22.5 mm Mounting Hole Style Handles Key Removal Position (Includes Latch) For Use With 194L-E 12...40 A, 194E-E16...63 A, -1753		194L-HCDC-001
	22.5 mm Mounting Hole Style Handles Key Removal Position (Includes Latch) For Use With 194L-E 12...40 A, 194E-E16...63 A, -1753		194L-HCDD-001
	22.5 mm Mounting Hole Style Handles Key Removal Position (Includes Latch) For Use With 194L-E 12...40 A, 194E-E16...63 A, -1753		194L-HCDG-001

Accessory Description	Pkg. Qty.	Cat. No.	Cat. No.
 Control Knob, Black, with Locking Facility (Use 1/4 in. max. hasp lock.) (Locks in 0°, 90°, 180°, and 270° positions)	10	*	194L-G2864N
Control Knob, Red, with Locking Facility (Use 1/4 in. max. hasp lock)		*	194L-G2864R

* These locking knobs can only be added to the "HE" style actuators. If a locking knob is desired on a "HC" style actuator, it has to be ordered as part of the main catalog number. For example, Cat. No. 194L-HC4E-175.

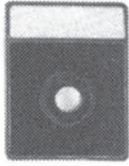
Accessory Description		Pkg. Qty.	Cat. No.
	Control Knob, Type P Control Knob, Black, 31 mm (1-7/32 in.) Diameter	5	194L-G2888N
	Control Knobs, Type P Control Knob, Red, 31 mm (1-7/32 in.) Diameter		194L-G2888R
	Control Knob, Black, L = 37.5 mm (1-31/64 in.)	5	194L-G3154N
	Control Knob, Black, L = 48 mm (1-57/64 in.)		194L-G3155N
	Control Knob, Red, L = 37.5 mm (1-31/64 in.)		194L-G3154R
	Control Knob, Red, L = 48 mm (1-57/64 in.)		194L-G3155R
	Rectangular front frame with blank nameplate L = 48 x 62 mm (1-57/64 x 2-7/16 in.)	10	194L-G3196
	Rectangular front frame with blank nameplate L = 64 x 78 mm (2-33/64 x 3-5/64 in.)		194L-G3197

Additional Legend Plates/Frames

	Color	Legend Size	For Use With	Pkg. Quantity	Legend Plate Marking	Cat. No.
	Black/Grey	19.2 mm x 49 mm 3/4 in. x 1-59/64 in.	Size 6 Type G and N style handles, Cat. Nos. 194L- HE6G/N	5	(Blank)	194L-G3667
					MAIN SWITCH	194L-G3667A
					HAUPTSCHALTER	194L-G3667B
					INTERR. PRINCIPALE	194L-G3667C
					INTERR. PRINCIPAUX	194L-G3667D
					INTERR. PRINCIPAL	194L-G3667E
					HUVUDBRYTARE	194L-G3667F
					WAHLSCHALTER	194L-G3667G
	EMERGENCY OFF	194L-G3667H				
	Black/Grey	18 x 84 mm 11/16 x 3-5/16 in.	Size 8 Type G and N style handles, Cat. Nos. 194L- HE8G/N	5	(Blank)	194L-G3515
					MAIN SWITCH	194L-G3515A
					HAUPTSCHALTER	194L-G3515B
					INTERR. PRINCIPALE	194L-G3515C
INTERR. PRINCIPAUX					194L-G3515D	
INTERR. PRINCIPAL					194L-G3515E	
HUVUDBRYTARE					194L-G3515F	
WAHLSCHALTER	194L-G3515G					
EMERGENCY OFF	194L-G3515H					

Legend Plates with Bezel	Legend Plate Color	Pkg. Quantity	Legend Plate Marking *		
			0-1	OFF-ON	Blank Legend Plate
			Cat. No.	Cat. No.	Cat. No.
	Silver	10	194L-A4-175	194L-A4-175I	194L-A4-000
			194L-A6-175	194L-A6-175I	194L-A6-000
			194L-A8-175	194L-A8-175I	194L-A8-000
	Yellow		194L-I4-175	194L-I4-175I	194L-I4-000
			194L-I6-175	194L-I6-175I	194L-I6-000
			194L-I8-175	194L-I8-175I	194L-I8-000

* Custom-Engraved legend plates available. To order, use publication 194L-PP002_-EN-P.

Shaft for Enclosures

Enclosure Type	Suitable For			Suitable For		
	194L (Base-Mounted Switches)	No. of Contacts	Shaft	Use with 194E Switch	No. of Poles	Shaft Required
194L-G3572	194L-A12(16)	1/2	194L-G3195	194E-A25(32)	3 and 4	194L-G3194
194L-G3576	194L-A12(16)	3/4	Standard			
(95 x 150 x 86 mm)	194L-A20(25)	1/2	194L-G3194			
	194L-A20(25)	3/4	Standard			
194L-G3573	194L-A12(16)	5/6	194L-G3195			
194L-G3577	194L-A12(16)	7/8	194L-G3194	—	—	—
(95 x 150 x 111 mm)	194L-A12(16)	9/10	Standard			
	194L-A20(25)	5/6	194L-G3194			
	194L-A20(25)	7/8	Standard			
194E-G3663	—	—	—	194E-A40(63)	3 and 4	194L-G3194
194E-G3664	—	—	—	194E-A25(32)	6	Standard
(125 x 180 x 105 mm)						
194E-G3665	—	—	—	194E-A80(100)	3 and 4	194E-G3707
194E-G3666	—	—	—	194E-A40(63)	6	Standard
(175 x 230 x 120 mm)						

Accessory Combinations in Enclosure

Enclosure Type	Switch	No. of Poles	Shaft	Aux. Contacts (single or double)	Additional Pole Block	On Switch		On Enclosure	
						Neutral Terminal Block	Ground Terminal Block	Neutral Terminal Block	Ground Terminal Block
194L-G3572 (ABS) 194L-G3576 (Noryl)	194E-A25(32)	3	194L-G3194	X	X				
				X		X			
				X			X		
					X		X		
				X				X	
				X					X
(95 x 150 x 86 mm)									
194E-G3663 (ABS) 194E-G3664 (Noryl)	194E-A40(63)	3	194L-G3194	X	X			X	X
				X		X		X	X
				X			X	X	X
					X		X	X	X
					X		X	X	X
					X		X	X	X
(125 x 180 x 105 mm)	194E-A25(32)	6	194E-G3707				X	X	
194E-G3665 (ABS) 194E-G3666 (Noryl)	194E-A80(100)	3	194E-G3707	X	X			X	X
				X		X		X	X
				X			X	X	X
					X		X	X	X
					X		X	X	X
					X		X	X	X
(175 x 230 x 120 mm)	194E-A40(63)	6	194E-G3707	1L+1R			X	X	

Electrical Ratings

Performance Data				16 A	25 A	32 A	40 A	63 A	80 A	100 A	Aux. Contacts	
IEC Applications												
Rated operational voltage (U_e): IEC*				[V]	690	690	690	690	690	690	690	690
Rated operational voltage (U_e): UL, CSA				[V]	600	600	600	600	600	600	600	600
Rated isolation voltage (U_i): IEC/UL, CSA				[V]	690/600	690/600	690/600	690/600	690/600	690/600	690/600	690/600
Rated impulse voltage (U_{imp}): UL, CSA				[kV]	8	8	8	8	8	8	8	8
Test voltage, (U_i) 1 minute				[kV]	2.5	2.5	2.5	2.5	2.5	2.5	2.5	2.5
Lost power per pole				[W]	0.58	1.0	1.5	1.6	2.4	3.6	5.5	0.4
Rated frequency				[Hz]	50/60	50/60	50/60	50/60	50/60	50/60	50/60	50/60
Conventional free air thermal current I_{th} *				[A]	25	40	50	63	75	100	120	12
Conventional enclosed thermal current I_e *				[A]	20	32	40	50	63	80	100	10
Rated current I_e*												
AC-1/	Non-inductive or only slightly inductive loads			[A]	16	25	32	40	63	80	100	10
AC-21A	Switching of resistive loads with slight overload											
Rated power P_e												
AC-23A	Occasional switching of 3Ø motors and other highly inductive loads (criterion for selecting main switches)	230V	[kW]	5.5	7.5	7.5	15	18.5	22	30	—	
		400V	[kW]	7.5	11	15	22	30	37	55	—	
		690V	[kW]	7.5	11	15	18.5	22	37	45	—	
AC-3	Squirrel-cage motors; starting and stopping of running motors	230V	[kW]	4	5.5	7.5	11	15	18.5	22	—	
		400V	[kW]	5.5	7.5	11	15	18.5	30	37	—	
		690V	[kW]	5.5	7.5	11	15	18.5	30	22	—	
Short circuit current (co-ordination type 2)				[kA]	20	20	15	20	15	30	25	—
Rated conditional short-circuit current				[A]	20	25	35	50	63	80	100	—
Maximum fuse rating of circuit (type g,G)				[A]	800	900	900	1300	1300	2500	2500	—
Rated short-time current I_{cw} (1 s)												
Rated breaking capacity AC23A (cosφ 0.45)												
230V				[A]	156	296	296	484	484	780	780	—
400V				[A]	120	256	256	504	504	800	800	—
690V				[A]	70	136	136	196	196	376	376	—
DC switching capacity												
Rated current I_e	1 pole	24/48V	[A]	20	25	32	40	63	80	100	—	
		110V	[A]	5	5	6	8	10	16	20	—	
		220V	[A]	1	1	1	1.5	1.5	3	3	—	
		440V	[A]	0.5	0.5	0.5	0.6	0.6	0.7	0.7	—	
DC-21A	2 poles in series	96V	[A]	20	25	32	40	63	80	100	—	
		110V	[A]	20	23	25	32	50	70	80	—	
		220V	[A]	5	5	6	8	10	16	20	—	
		440V	[A]	1	1	1	1.5	1.5	3	3	—	
DC-21A	3 poles in series	600V	[A]	0.6	0.6	0.6	0.8	0.8	1	1	—	
		110V	[A]	20	25	32	40	63	80	100	—	
		220V	[A]	13	13	15	20	28	50	63	—	
		440V	[A]	2.2	2.2	2.2	3.6	3.6	6.5	6.5	—	
600V				[A]	1.3	1.5	1.5	2	2	3	3	—
Rated power P_e												
DC-23A, DC-3, DC-5	3 poles in series	90V	[kW]	1	1.3	1.5	2.9	4.1	5.1	7.2	—	
		110V	[kW]	1	1.1	1.3	2.2	3.3	5.5	7	—	
		220V	[kW]	0.8	0.9	1.1	1.7	2	3.5	4.4	—	
		440V	[kW]	0.6	0.6	0.6	0.9	0.9	1.1	1.1	—	
		600V	[kW]	0.4	0.4	0.4	0.5	0.5	0.9	0.9	—	

* See standards compliance listed on page 2-404.

* Suitable also for SEV 500.

Bulletin 194E
IEC Load Switches, 16...100 A
 Specifications

Electrical Ratings, Continued

Performance Data		16 A	25 A	32 A	40 A	63 A	80 A	100 A	Aux. Contacts	
UL/CSA Applications										
Continuous current	[A]	16	25	32	40	63	80	100	—	
	Heavy Pilot Duty	[AC]	A600	A600	A600	—	—	—	A600	
	Standard Duty	[DC]	—	—	—	—	—	—	Q600	
	Motor rating 60 Hz	120V, 1P	FLA	16	16	16	24	34	56	80
			Hp	1	1	1	2	3	5	7.5
		240V, 1P	FLA	12	12	17	17	28	50	68
			Hp	2	2	3	3	5	10	15
		480V, 1P	FLA	8.5	8.5	14	21	26	34	68
			Hp	3	3	5	7.5	10	15	30
	600V, 1P	FLA	11.2	11.2	11.2	16	20	27	44	
		Hp	5	5	5	7.5	10	15	25	
	Three-phase	120V, 3P	FLA	13.6	13.6	19.2	30.4	40	56	84
Hp			2	2	3	5	7.5	10	15	
240V, 3P		FLA	9.6	15.2	22	28	42	68	80	
		Hp	3	5	7.5	10	15	25	30	
480V, 3P		FLA	11	14	21	27	34	52	65	
		Hp	7.5	10	15	20	25	40	50	
600V, 3P		FLA	11	11	17	22	27	52	52	
		Hp	10	10	15	20	25	50	50	

Mechanical Data

Performance Data		16 A	25...32 A	40...63 A	80...100 A	Aux. Contacts	
Protection class according to IEC 529							
Motor rating 60 Hz							
handles		IP66	IP66	IP66	IP66	IP66	
switch bodies		IP20	IP20	IP20	IP20	IP20	
Mechanical life	[million operations]	0.2	0.2	0.2	0.2	0.2	
Max wire gauges							
Terminal size per IEC 947-1							
rigid wire	1/2 conductor	AWG mm ²	A4	A6	A7	A9	2xA2
			(1)16...10/(2)16...12 (1)1...10/(2)1...4	(1)14...8/(2)14...10 (1)1.5...16/(2)1.5...6	(1)12...4/(2)12...8 (1)2.5...25/(2)2.5...16	(1)10...1/(2)10...4 (1)4...50/(2)4...25	18...14 0.75...2.5
fine strands	1/2 conductor	AWG mm ²	(1)16...8/(2)16...12 (1)1.5...6/(2)1.5...4	(1)14...8/(2)14...10 (1)1.5...10/(2)1...6	(1)12...4/(2)12...8 (1)2.5...16/(2)2.5...10	(1)10...1/(2)10...6 (1)4...35/(2)4...16	18...14 0.5...2.5

Environmental Data

Storage	-40...+80 °C (-40...+176 °F)
Operation	-25...+60 °C (-13...+140 °F)

Dimensions are shown in millimeters (inches). Dimensions are not intended to be used for manufacturing purposes.

Front Installation Cat. No. 194E-E...

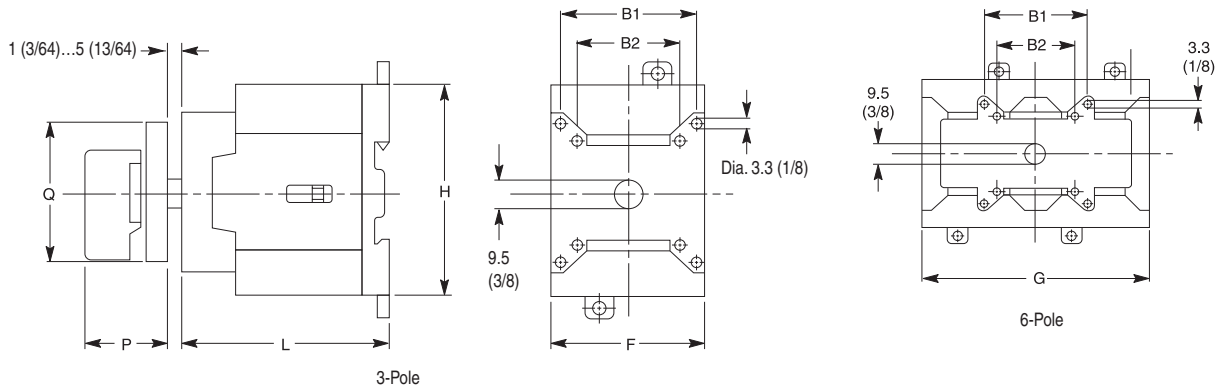

Cat. No.	Handles	
	P	Q
194L-HE4A	28 (1-7/64)	48 x 48 (1-57/64 x 1-57/64)
194L-HE4I	28 (1-7/64)	48 x 48 (1-57/64 x 1-57/64)
194L-HE4S	28 (1-7/64)	48 x 62 (1-57/64 x 2-7/16)
194E-HE4N	34 (1-11/32)	54 x 54 (2-1/8 x 2-1/8)
194E-HE4G	34 (1-11/32)	54 x 54 (2-1/8 x 2-1/8)
194L-HE6A	28 (1-7/64)	64 x 64 (2-33/64 x 3-5/64)
194L-HE6I	28 (1-7/64)	64 x 64 (2-33/64 x 3-5/64)
194L-HE6S	28 (1-7/64)	64 x 78 (2-33/64 x 3-5/64)
194L-HE6N	34 (1-11/32)	67 x 67 (2-41/64 x 2-41/64)
194L-HE6G	34 (1-11/32)	67 x 67 (2-41/64 x 2-41/64)

Use with Cat. No.	Switch Body					
	B1*	B2	F	H	L*	G
194E-E16	28 (1-7/64)	N/A	36 (1-37/64)	63 (2-31/64)	51 (2)	90 (3-35/64)
194E-E25/32	36 (1-27/64)	N/A	45 (1-25/32)	64 (2-33/64)	60 (2-3/8)	90 (3-1/2)
194E-E40/63	48 (1-57/64)	36 (1-27/64)	54 (2-1/8)	72 (2-27/32)	74 (2-29/32)	108 (4-1/4)
194E-E80/100	48 (1-57/64)	36 (1-27/64)	72 (2-27/32)	90 (3-35/64)	90 (3-35/64)	144 (5-11/16)

* Does not apply to 194E-40/63A, 6-Pole Switches. Use B2 dimensions for 6-pole devices.

* For 6-pole switches, add 1 in. to the "L" dimension.

Cat. No. 194E-E Switch Body with Cat. No. 194L-HC4A Handle for 22.5 mm Hole Mounting Style

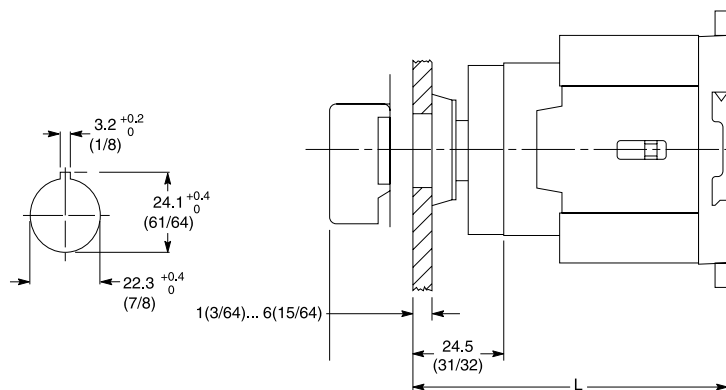

Type	L
194E-E16	76 (3)
194E-E25/32	84.5 (3-21/64)
194E-E40/63	98.5 (3-7/8)
194E-E80/100	114.5 (4-33/64)

Bulletin 194E
IEC Load Switches, 16...100 A
 Appropriate Dimensions

Dimensions are shown in millimeters (inches). Dimensions are not intended to be used for manufacturing purposes.

Base Mounting Cat. No. 194E-A...

2

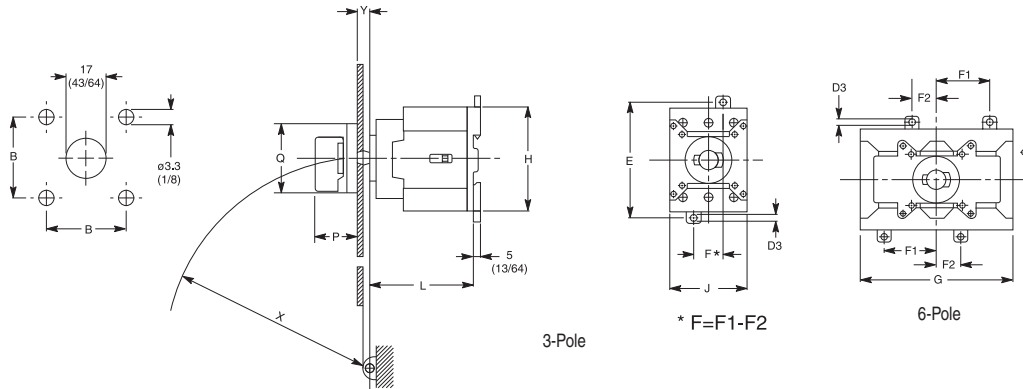

Handles		
Cat. No.	P	Q
194L-HE4A	28 (1-7/64)	48 x 48 (1-57/64 x 1-57/64)
194L-HE4I	28 (1-7/64)	48 x 48 (1-57/64 x 1-57/64)
194L-HE4S	28 (1-7/64)	48 x 62 (1-57/64 x 2-7/16)
194E-HE4N	34 (1-11/32)	54 x 54 (2-1/8 x 2-1/8)
194E-HE4G	34 (1-11/32)	54 x 54 (2-1/8 x 2-1/8)
194L-HE6A	28 (1-7/64)	64 x 64 (2-33/64 x 3-5/64)
194L-HE6I	28 (1-7/64)	64 x 64 (2-33/64 x 3-5/64)
194L-HE6S	28 (1-7/64)	64 x 78 (2-33/64 x 3-5/64)
194L-HE6N	34 (1-11/32)	67 x 67 (2-41/64 x 2-41/64)
194L-HE6G	34 (1-11/32)	67 x 67 (2-41/64 x 2-41/64)

Cover Requirements				
For Use With	Y min.	X \geq	Y max.	X \geq
194E-A16	5 (13/64)	142 (5-19/32)	9.5 (3/8)	90 (3-35/64)
194E-A25/32	5 (13/64)	142 (5-19/32)	9.5 (3/8)	90 (3-35/64)
194E-A40/63	2.5 (7/64)	150 (5-29/32)	9.5 (3/8)	90 (3-35/64)
194E-A80/100	2.5 (7/64)	150 (5-29/32)	9.5 (3/8)	90 (3-35/64)

Switch Body								
Use With Cat. No.	D3	E	F1	F2	G	H	L *	J
194E-A16	4.5 (3/16)	70 (2-49/64)	45 (1-25/32)	12.5 (31/64)	90 (3-35/64)	63 (2-31/64)	80 (3-5/32)	36 (1-27/64)
194E-A25/32	4.5 (3/16)	70 (2-49/64)	30 (1-3/16)	15 (19/32)	90 (3-1/2)	64 (2-33/64)	59 (2-5/16)	45 (1-25/32)
194E-A40/63	4.5 (3/16)	80 (3-5/32)	37 (1-15/32)	17 (43/64)	108 (4-1/4)	72 (2-27/32)	73 (2-55/64)	54 (2-1/8)
194E-A80/100	5.6 (7/32)	95 (3-3/4)	48.5 (1-29/32)	23.5 (59/64)	144 (5-11/16)	90 (3-35/64)	89 (3-1/2)	72 (2-27/32)

* For 6-pole switches, add 1 in. to the "L" dimension.

Dimensions are shown in millimeters (inches). Dimensions are not intended to be used for manufacturing purposes.

Base Mounting Cat. No. 194E-A...

Cat. No. 194E-A... Switch Body with Cat. No. 194L-G2853 Shaft Extension

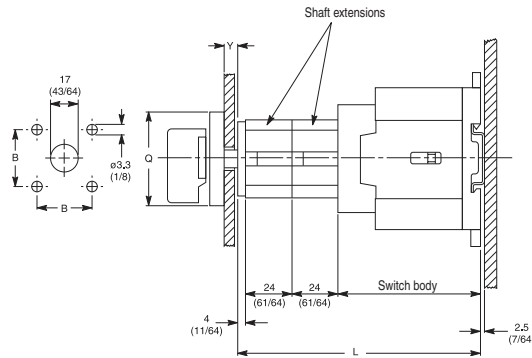

Switch Body				
L *	Cat. No.			
	194E-A 16	194E-A 25/32	194E-A 40/63	194E-A 80/100
With 1 shaft extension	79 (3-7/64)	88 (3-15/32)	102 (4-1/32)	118 (4-21/32)
With 2 shaft extensions	103 (4-37/64)	112 (4-27/64)	126 (4-31/32)	142 (5-19/32)
With 3 shaft extensions	127 (5)	136 (5-23/64)	150 (5-29/32)	166 (6-35/64)
With 4 shaft extensions	151 (6-61/64)	160 (6-5/16)	174 (6-55/64)	190 (7-31/64)
With 5 shaft extensions	175 (7-57/64)	184 (7-1/4)	198 (7-51/64)	214 (8-7/16)
With 6 shaft extensions	199 (8-27/32)	208 (8-13/64)	222 (8-3/4)	238 (9-3/8)

* For six-pole switches, add 1 in. to the "L" dimension.

Shaft	Y
194L-G2830	2.5...9.5 (7/64...3/8)
194L-G3194	9...18 (23/64...23/32)
194L-G3195	14...23 (9/16)...(29/32)

Handles			
Type	B	Q	P
194L-HE4A	36 (1-27/64)	48 x 48 (1-57/64 x 1-57/64)	28 (1-7/64)
194L-HE4I	36 (1-27/64)	48 x 48 (1-57/64 x 1-57/64)	28 (1-7/64)
194E-HE4G	28 (1-7/64)	54 x 54 (2-1/8 x 2-1/8)	34 (1-11/32)
194E-HE4N	28 (1-7/64)	54 x 54 (2-1/8 x 2-1/8)	34 (1-11/32)
194L-HE6A	48 (1-57/64)	64 x 64 (2-33/64 x 2-33/64)	28 (1-7/64)
194L-HE6I	48 (1-57/64)	64 x 64 (2-33/64 x 2-33/64)	28 (1-7/64)
194L-HE6N	48 (1-57/64)	67 x 67 (2-41/64 x 2-41/64)	34 (1-11/32)
194L-HE6G	48 (1-57/64)	67 x 67 (2-41/64 x 2-41/64)	34 (1-11/32)

Bulletin 194E
IEC Load Switches, 16...100 A
 Appropriate Dimensions

Dimensions are shown in millimeters (inches). Dimensions are not intended to be used for manufacturing purposes.

Base Installation Cat. No. 194E-A...

Cat. No. 194E-A Switch Body with Metal Shaft Extension

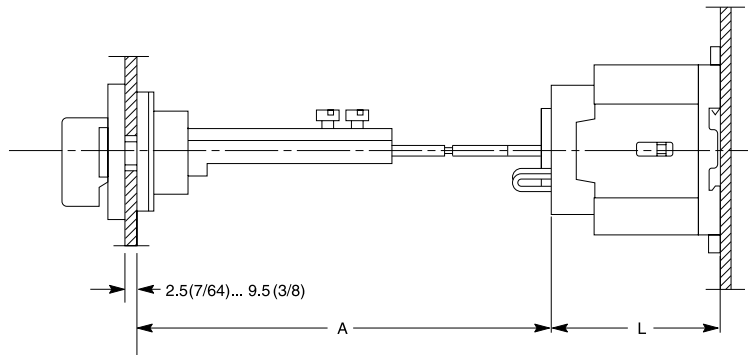

Cat. No.	A
194L-G3393	110...235 (4-11/32...9-1/4)
194L-G3394	230...350 (9-1/16...13-25/32)

Cat. No.	L*
194E-A16	51 (2)
194E-A25/32	60 (2-3/8)
194E-A40/63	74 (2-59/64)
194E-A80/100	90 (3-35/64)

* For 6-pole switches, add 1 in. to the "L" dimension.

Base and Front Installation

Cat. No. 194E... with Auxiliary Contact Block Installed

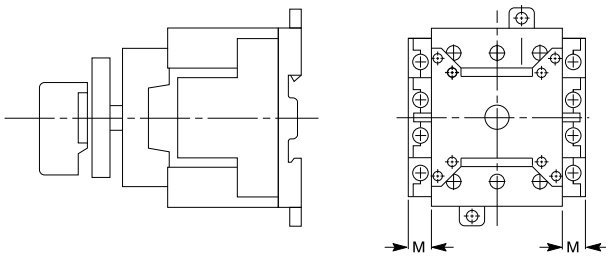

Contacts	M
1 N.O. + 1 N.C.	9 (23/64)
2 N.O. + 2 N.C.	18 (23/32)

Cat. No. 194E... with 4-Pole, Ground and Neutral Terminals

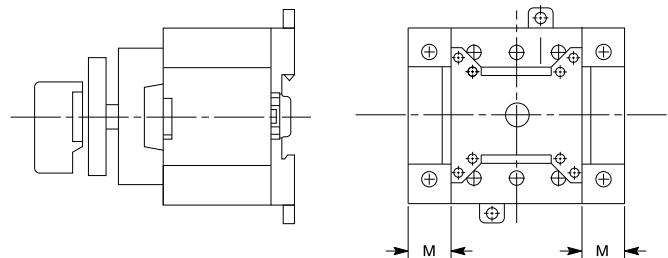

Cat. No.	M
194E-16	12.5 (31/64)
194E-25/32	14 (9/16)
194E-40/63	17.5 (11/16)
194E-80/100	22 (7/8)

Dimensions are shown in millimeters (inches). Dimensions are not intended to be used for manufacturing purposes.

Base Mounting Cat. No. 194E-A...

Thermoplastic Enclosures

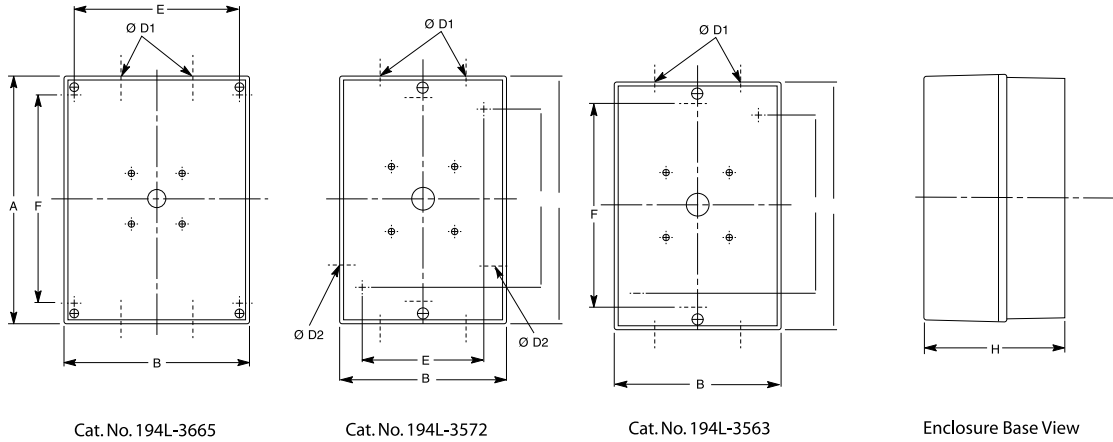

Complete Switches	Enclosures		Height A	Width B	Knockouts* ØD1		Mounting Holes‡		Depth H	
	Cat. No.	Cat. No.					E	F		
194E-Y16	3 and 4	*	*	120 (4-23/32)	70 (2-3/4)	M16/M20 16/20 mm	PG11/PG16 18.5/22.5 mm	50 (1-31/32)	105 (4-9/64)	70 (2-49/65)
	6	194E-G3663	194E-G3664	180 (7-3/32)	125 (4-59/64)	M25/M30 25/30 mm	PG21/PG29 28.5/37.5 mm	On Center	145 (5-23/32)	105 (4-1/8)
194E-Y25/32	3 and 4	194L-G3572	194L-G3576	150 (5-29/32)	95 (3-3/4)	PG16/PG21 22.5/28.5 mm		60 (2-3/8)	115 (4-17/32)	86 (3-3/8)
	6	194E-G3663	194E-G3664	180 (7-3/32)	125 (4-59/64)	PG21/PG29 28.5/37.5 mm		On Center	145 (5-23/32)	105 (4-1/8)
194E-Y40/63	3 and 4	194E-G3663	194E-G3664	180 (7-3/32)	125 (4-59/64)	PG21/PG29 28.5/37.5 mm		On Center	145 (5-23/32)	105 (4-1/8)
	6	194E-G3665	194E-G3666	230 (9-1/16)	175 (6-57/64)	PG29/PG36 37.5/47.5 mm		155 (6-3/32)	195 (7-43/64)	120 (4-47/64)
194E-Y80/100	3 and 4	194E-G3665	194E-G3666	230 (9-1/16)	175 (6-57/64)	PG29/PG36 37.5/47.5 mm		155 (6-3/32)	195 (7-43/64)	120 (4-47/64)

* Empty enclosures not available for purchase.
 * Cat. No. 194E-A16 units have 1 knockout on each end, all others have 2 knockouts on each end. A letter "M" in the catalog number indicates metric knockouts; the unit is otherwise supplied with PG knockouts.
 ‡ All mounting holes have a 4.2 mm (5/32 in.) diameter.

No. of Extensions	Cat. No. 194E-A 20/32...	Cat. No. 194E-A 40/63...	Cat. No. 194E-A 80/00...
With 1 extension	96 (3-25/32)	107 (4-7/32)	114 (4-31/64)
With 2 extensions	120 (4-23/32)	131 (5-5/32)	138 (5-7/16)
With 3 extensions	144 (5-43/64)	155 (6-7/64)	162 (6-3/8)
With 4 * extensions	168 (6-39/64)	179 (7-3/64)	186 (7-21/64)
With 5 * extensions	192 (7-9/16)	203 (8)	210 (8-17/64)
With 6 * extensions	216 (8-1/2)	227 (8-15/16)	234 (9-7/32)

* When more than 4 modules are used, attach the first one to the switch body using the screws supplied with the extension (Cat. No. 194L-G2853).

Bulletin 194E
IEC Load Switches, 16...100 A
 Appropriate Dimensions

Dimensions are shown in millimeters (inches). Dimensions are not intended to be used for manufacturing purposes.

194E Enclosed Switches with 194R Handles

2

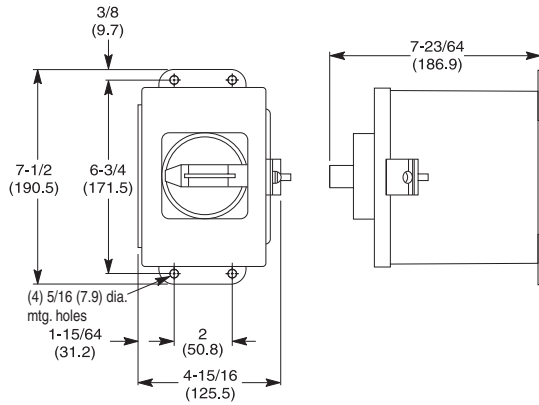

Cat. Nos. 194E-CA16...63, 194E-FA16...63, 194E-AA16...63

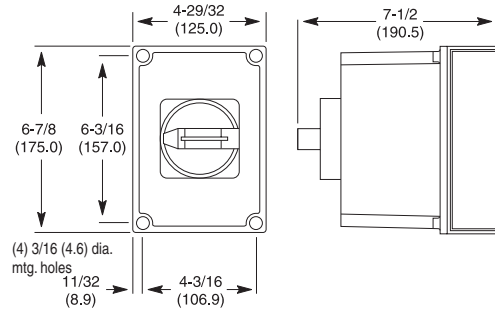

Cat. No. 194E-KA16...63

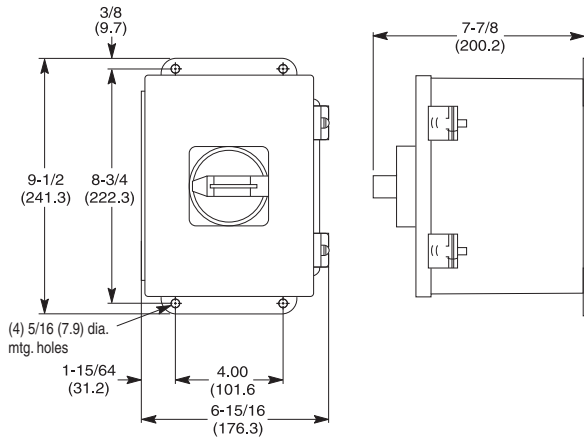

Cat. Nos. 194E-CA80...00, 194E-FA80...00, 194E-AA80...00
 Cat. Nos. 194E-CA40X...63X, 194E-FA40X...63X, 194E-AA40X...63X

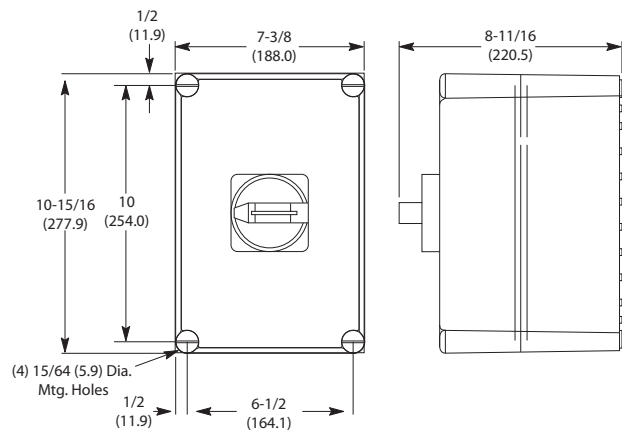

Cat. No. 194E-KA80...00

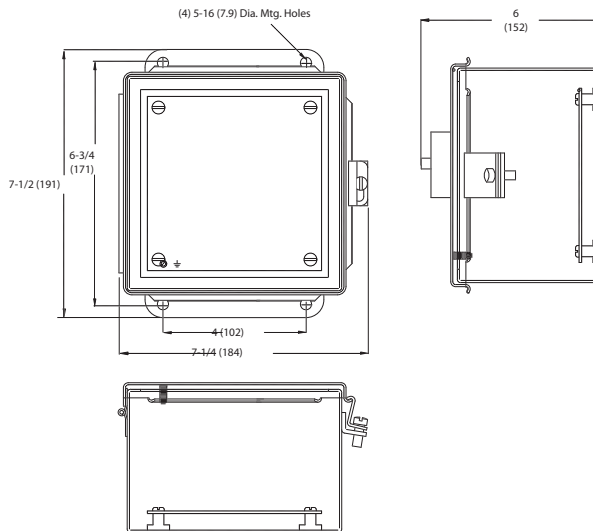

Cat. No. 194E-DA16...32, 194E-GA16...32